



HAL
open science

Correlated Random Walk of tuna in arrays of Fish Aggregating Devices: A field-based model from passive acoustic tagging

Géraldine Pérez, Amaël Dupaix, Laurent Dagorn, Jean-Louis Deneubourg,
Kim Holland, Sunil Beeharry, Manuela Capello

► **To cite this version:**

Géraldine Pérez, Amaël Dupaix, Laurent Dagorn, Jean-Louis Deneubourg, Kim Holland, et al.. Correlated Random Walk of tuna in arrays of Fish Aggregating Devices: A field-based model from passive acoustic tagging. *Ecological Modelling*, 2022, 470, pp.110006. 10.1016/j.ecolmodel.2022.110006 . hal-03688126

HAL Id: hal-03688126

<https://hal.umontpellier.fr/hal-03688126>

Submitted on 17 Jan 2024

HAL is a multi-disciplinary open access archive for the deposit and dissemination of scientific research documents, whether they are published or not. The documents may come from teaching and research institutions in France or abroad, or from public or private research centers.

L'archive ouverte pluridisciplinaire **HAL**, est destinée au dépôt et à la diffusion de documents scientifiques de niveau recherche, publiés ou non, émanant des établissements d'enseignement et de recherche français ou étrangers, des laboratoires publics ou privés.

Correlated Random Walk of tuna in arrays of Fish Aggregating Devices: A field-based model from passive acoustic tagging

Pérez Géraldine ^{1,*}, Dupaix Amael ¹, Dagorn Laurent ¹, Deneubourg Jean-Louis ², Holland Kim ³, Beeharry Sunil ⁴, Capello Manuela ¹

¹ MARBEC, Univ Montpellier, CNRS, Ifremer, IRD, Sète, France

² Unit of Social Ecology, Université Libre de Bruxelles (ULB), Bruxelles, Belgium

³ Hawai'i Institute of Marine Biology at University of Hawai'i, Kane'ohe, Hawai'i, United States of America

⁴ Ministry of Ocean Economy, Marine Resources, Fisheries and Shipping, Mauritius

* Corresponding author : Géraldine Pérez, email address : geraldine.perez@ntymail.com

Abstract :

For centuries fishers have exploited the propensity for tuna to associate with floating objects, yet the reasons and mechanisms behind this behavior remain unclear. The number of man-made floating objects (FADs, Fish Aggregating Devices) undergone a dramatic increase in recent decades, with the development of industrial tuna purse seine fishing. However, current knowledge does not allow for the evaluation of the consequences of this increase on the ecology of tuna. Here, we developed a model of tuna movements in an array of FADs, using passive acoustic tagging data. The model was built using four behavioral rules: (1) when no FAD is perceived, tuna exhibit a random search behavior, (2) individuals can orient directly to a FAD when they perceive it (within a given orientation radius), (3) the associative dynamics of tuna follow a daily rhythm and (4) Continuous Residence Time (CRTs – time spend at FAD by tuna) are independent from previous Continuous Absent Time (CATs- time between two consecutive CRTs). The model is based on only four parameters: swimming speed, path sinuosity, orientation distance and a loss term to account for natural and fishing mortality events. The model was calibrated on 70±10 cm yellowfin tuna (*Thunnus albacares*), acoustically tagged in two different networks of anchored FADs (Oahu, Hawaii, U.S.A. and Mauritius) with different FAD densities. Our results show that the model can reproduce the time tuna spent traveling between FADs (i.e., time away from the FADs), as well as the total time spent by the fish in the FAD array (total residence time) at both study sites. The parameter sets that best reproduce the experimental data correspond to a steering radius between 2 and 5 km, a sinuosity (correlated random walk parameter) between 0.9 and 0.995 and mortality rates between 1 and 3% per day. This model, thus parameterized, could be used in future studies to predict tuna movements in arrays of different FAD densities and thus provide scientific advice for their management. The same approach can be used for modeling the movements of marine and terrestrial animals detected near aggregation sites.

Highlights

► First model to reproduce tuna movements in an array of Fish Aggregating Device. ► Calibration of the model parameters using passive acoustic telemetry data. ► This model can be used to evaluate the impact of increasing numbers of aggregation sites on the movement behavior of animals.

Keywords : Correlated Random Walk, Tropical tuna, Spatial model, Fish Aggregating Device, Acoustic tagging, Survival curve, Tuna motion, Residency

47 **1. Introduction**

48 With more than 5.3 million tonnes caught in 2019 (ISSF, 2021) tropical tuna constitutes one of the
49 major harvested fish species. Currently, yellowfin tuna (*Thunnus albacares*), bigeye tuna (*T. obesus*)
50 and skipjack (*Katsuwonus pelamis*) represent almost 95% of the global tuna catches (ISSF, 2021).
51 Tropical tunas display an associative behavior with floating objects, forming large multi-specific
52 aggregations around them. The reasons why tuna associate with floating objects are still unknown.
53 Two main hypotheses are widely accepted: (1) the meeting-point hypothesis (Dagorn & Fréon 1999,
54 Fréon & Dagorn, 2000) and (2) the indicator-log hypothesis (Hall, 1992). The meeting-point
55 hypothesis posits that floating objects act as meeting-points, where tuna gather to form bigger schools.
56 The indicator-log hypothesis posits that natural floating objects, such as logs, are more numerous in
57 productive areas, as they concentrate in river mouths, estuaries and frontal structures. Following this
58 hypothesis, tuna could use floating objects as indicators of productive areas.
59 Fishers have used this associative behavior to their advantage for centuries (Dempster & Taquet,
60 2004) and, more recently, have deployed human-made floating objects, called Fish Aggregating
61 Device (FAD), to increase their catches. In the open ocean, drifting FADs are primarily used by
62 industrial purse seine fleets, while, in coastal areas, anchored FADs are used by artisanal and semi-
63 industrial fisheries (Dagorn et al. 2013b; Dempster & Taquet, 2004; Scott & Lopez, 2014). About
64 37% of the tropical tuna catches (all fishing gears) are made by purse seiners on drifting FADs,
65 ranging between 32% to 51% depending of the ocean (Dagorn et al. 2013b; Murua et al. 2021). The
66 number of FADs has drastically increased in the three past decades, with more than 100,000 FADs
67 deployed globally, each year (Scott & Lopez, 2014), although precise numbers are difficult to obtain.

68 This increase raised concerns over possible impacts on tuna populations, because FADs increase the
69 vulnerability of tunas to capture but also because increasing the number of floating objects (Dagorn
70 et al. 2013b) could affect their ecology. Marsac et al. (2000), were the first to suggest that FADs could
71 act as an ecological trap for tunas. Following the indicator-log hypothesis, FADs could mislead tuna
72 if they are deployed or drift into biologically poor areas and if tuna do not differentiate between
73 natural and man-made objects. Therefore, tuna could remain associated with FADs even if their
74 surrounding environment is detrimental to their fitness (Marsac et al. 2000). However, current
75 knowledge does not allow for the assessment of the effects of increasing FAD densities on tuna
76 ecology, even when the environment (other than floating objects) remains constant.

77 Acoustic telemetry has been widely used to monitor tuna movements and behavior within FAD arrays.
78 With this technology, acoustically tagged fish (i.e., fish equipped by an acoustic tag) can be either
79 actively tracked or detected by a set of fixed acoustic receivers. In the former case, known as *active*
80 *tracking*, the recorded path of the receiver, which is considered as a proxy of the animal path,
81 generally corresponds to short periods of time (few days at most) (Girard et al. 2004; Girard et al.
82 2007). In the latter case, known as *passive acoustic telemetry*, a time series of acoustic detections is
83 recorded within the array of receivers (Dagorn et al. 2007; Tolotti et al. 2020). The acoustic receivers
84 are generally placed in proximity of aggregation/attraction sites (FADs in this case), where it is more
85 likely to detect the tagged individuals. Passive acoustic telemetry has the advantage to cover longer
86 period of time (up to several months or even more than a year, depending on the tag battery life and
87 the fish residency within the array). However, the time series of acoustic detections recorded at
88 aggregation sites cannot be easily translated into movement rules.

89 Previous passive acoustic telemetry studies conducted in anchored FAD arrays quantified the amount
90 of time that tuna spend associated with these floating objects (residence times), as well as the time
91 they spend traveling between two objects (absence times) (Dagorn et al. 2007; Govinden et al., 2013;
92 Robert et al., 2013; Rodriguez-Tress et al., 2017). These studies highlighted the variability of such
93 durations according to both the size of the tagged individuals (Robert et al., 2013) as well as the
94 species (Rodriguez-Tress et al., 2017). Recently, Pérez et al. (2020) compared the residence and
95 absence times recorded for individual tuna tagged within different FAD arrays, demonstrating that
96 tuna spend less time traveling between FADs and more time in association as FAD density increases.

97 Passive and active acoustic telemetry studies have also shown a diel rhythm in the associative
98 behavior of tunas, with close association occurring mostly during the daytime while regular
99 excursions away from the FAD are undertaken at night (Holland et al. 1990; Marsac & Cayré, 1998;
100 Dagorn, et al. 2000; Forget et al., 2015; Tolotti et al., 2020). Furthermore, active tracking studies
101 allowed the fine-scale movements of tagged individuals in arrays of FADs to be investigated. Using
102 acoustic telemetry data from actively tracked yellowfin tuna in anchored FAD arrays in the Pacific

103 and Indian oceans, Girard et al. (2004) found that tuna adopt a random search behavior until they
104 perceive a FAD, then orient towards the device at distances ranging between 4 to 17 km.
105 Recently, Pérez et al. (2020), used a simple random walk model to assess whether the observed trends
106 in behavioural indices, obtained from passive acoustic tagging data across increasing FAD densities,
107 could result from the random-search component in tuna behaviour suggested in previous experiments
108 (Girard et al. 2004). While this simple model was able to explain the observed trends of shorter
109 absence times for increasing FAD densities, it could not quantitatively predict their durations, since
110 it did not account for the oriented movements (Girard et al. 2004) or for the diel pattern in tuna
111 behavior (Marsac & Cayré, 1998; Forget et al., 2015). Correlated Random Walk (CRW) models are
112 frequently used to reconstruct animal paths from active tracking data (e.g. Girard et al. 2004;
113 Patterson et al. 2009; McClintock et al. 2012; Cramer et al. 2021), as well as to simulate their
114 movements (Byers, 2001; Carita et al. 2012; Ahearn et al. 2017; Cramer et al. 2021). These models
115 are used because, unlike a simple random walk, they account for the tendency of animals to go
116 forward. A CRW model is thus a better choice than a simple random walk for animals with bilateral
117 symmetry such as tuna. On the other hand, despite the large availability of passive acoustic telemetry
118 data for tuna and their large temporal coverage, this data has not been used so far to construct this
119 type of models, due to the discrete nature of the data (acoustic detections) recorded both in time and
120 space.

121 The aim of this study was to develop a data-based model of tuna movements in an array of FADs,
122 which can reproduce the motion of tuna from one FAD association to another detected through
123 passive acoustic telemetry. Such model constitutes the first step to predict the effects of increasing
124 FAD numbers on tuna behavior and ecology. The model was calibrated using passive acoustic
125 telemetry data collected at two study sites (Mauritius, see Rodriguez-Tress et al. 2017, and Oahu,
126 Hawaii, U.S.A., see Dagorn et al. 2007; Robert et al. 2013) with different FAD densities (Pérez et al.
127 2020).

128

129

130 **2. Materials & Methods**

131 **2.1. Field data**

132 Passive acoustic telemetry data were used to characterize tuna movements in FAD arrays. This
133 technology is based on the transmission of an acoustic signal between an acoustic transmitter (or tag)
134 implanted in a tuna and acoustic receivers (or hydrophones) installed at specific study sites. The
135 identification of the tagged fish is possible when the fish is located close to the receivers, within a
136 given detection range. Passive acoustic tagging data were collected in two anchored FAD arrays, one
137 around the island of Mauritius (Rodriguez-Tress et al. 2017) in the Western Indian Ocean, and the

138 other around the island of Oahu (Robert et al. 2013), within the Hawaiian archipelago in the Central
139 Pacific Ocean (Fig. 1). These anchored FAD arrays differ in their inter-FAD distances, with the
140 Mauritian array having shorter nearest and next-nearest neighboring distances than the Hawaiian
141 array (Pérez et al., 2020). The Mauritian array consisted of 9 FADs with 7 equipped with acoustic
142 receivers, and the Hawaiian array comprised 13 FADs, all of which were equipped with acoustic
143 receivers (see Dagorn et al. 2007; Rodriguez-Tress et al. 2017 for specifications of acoustic receivers).
144 In both arrays, FADs were moored in depths of between 1000 and 2500 m. The design of FADs was
145 similar within the same array, but differed slightly between arrays.

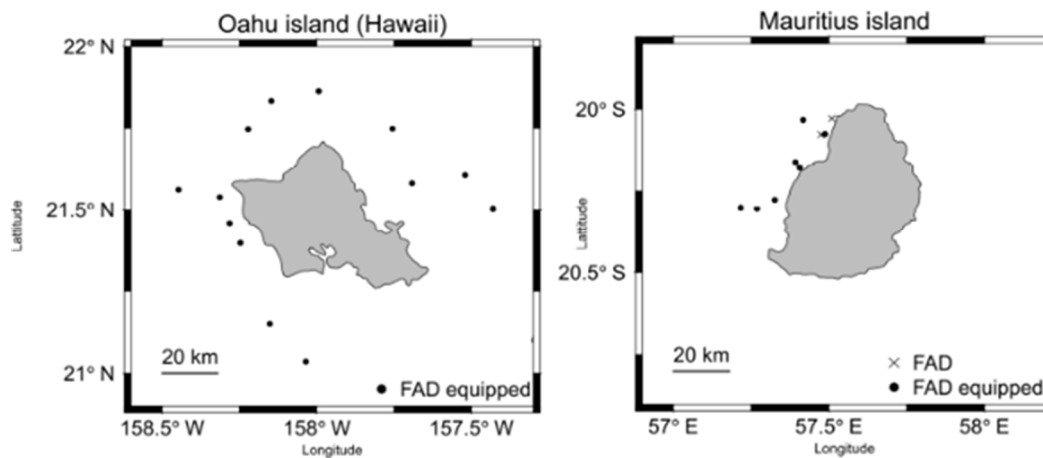

146
147 **Fig. 1:** Anchored FAD arrays of Mauritius (left) and Oahu (right). Positions of the anchored FADs
148 are represented by a black dot when equipped with an acoustic receiver, and by a black cross
149 otherwise.

150
151 Since previous studies outlined species and size-dependent variability in the associative behavior of
152 tuna at FADs (Robert et al. 2013; Rodriguez-Tress et al. 2017; Pérez et al., 2020), this study focused
153 on a single species (yellowfin tuna) and size of ~70 cm fork length (fork length range: 60-80 cm),
154 named YFT-70, which was common to both study sites. For the Mauritian array, due to the short
155 duration of the experiment (Rodriguez-Tress et al. 2017), the data recorded during the first 38 days
156 was considered, resulting in the smallest observation time. For the Hawaiian array, where the
157 experiment lasted more than one year, only the initial 120 days after tagging were considered because
158 95% of the time between the first and the last detection at a FAD lasted less than 120 days (Robert et
159 al. 2013). As a result, the field data consisted of 14 YFT-70 tagged in the Mauritian array and 56 YFT-
160 70 individuals in the Hawaiian array (Table 1). Details on the tagging procedures can be found in
161 Rodriguez-Tress et al. (2017) for the Mauritian array and in Robert et al. (2013) for the Hawaiian
162 array.

163

Table 1: Number of yellowfin tuna of ~70 cm tagged (N_{tuna}), total number of CRTs (excluding the first CRT, NCRT) and total number of CAT_{diff} ($NCAT_{diff}$) recorded in the Mauritian and the Hawaiian array.

	Hawaii	Mauritius
N_{tuna}	56	14
NCRT	111	29
$NCAT_{diff}$	59	19

164

165 2.2. Residence and absence times in the FAD array

166 Acoustic telemetry data were processed to obtain information on durations of presence at and absence
 167 from instrumented FADs displayed by tagged tuna, following the procedure described in Capello et
 168 al. (2015). This procedure translates the discrete time series of acoustic detections into continuous
 169 bouts of time. It relies on the definition of a maximum blanking period (MBP), i.e., a maximum
 170 temporal separation between two subsequent acoustic detections at the same FAD (or receiver), where
 171 fish is still considered to be associated. The definition of a MBP not only allows to account for small
 172 data gaps related to detection issues and sonic collisions (Forget et al. 2015), but also for fish
 173 excursions out of the detection range of the receiver. In the case of tropical tuna, a MBP value of 24h
 174 was chosen, in order to account for the regular diel excursions that tuna perform out of the FAD at
 175 nighttime (Holland et al. 1990; Marsac & Cayré, 1998; Dagorn et al. 2000; Forget et al. 2015).
 176 Following this procedure, the Continuous Residence Times (CRTs) (Ohta & Kakuma 2005; Dagorn
 177 et al. 2007; Capello et al. 2015), corresponded to continuous bouts of time spent at the same FAD
 178 without any day-scale absence (>24h). Conversely, the time spent away from FADs were defined as
 179 Continuous Absence Times (CAT) (Govinden et al. 2013; Capello et al. 2015). Absence times related
 180 to movements between two different FADs were referred to as CAT_{diff} (Pérez et al. 2020). Finally, for
 181 each individual, the sum of all recorded CRTs and CATs corresponded to the Total Residence Time
 182 (TRT), namely the time between the first and the last detection recorded in the FAD array (Fig. 2).

183

184 2.3. Model

185 The model was built upon four behavioral rules, based on the current knowledge of the associative
 186 behavior of tuna at FADs (Fig. 3): (1) Tuna display a random search behavior between two FAD
 187 associations (Girard et al. 2004; Pérez et al. 2020), (2) at a certain distance from FADs tuna show
 188 oriented movements towards FADs (Girard et al. 2004), (3) the tuna association dynamics follows a
 189 diel rhythm (Holland et al. 1990; Marsac & Cayré 1998; Dagorn et al. 2000; Forget et al. 2015; Tolotti

190 et al., 2020; Govinden et al. 2021), and (4) CRTs were independent from previous CATs (Robert et
 191 al. 2013).

192 As tuna, like most animals, have a tendency to move forward, the random-search movements were
 193 simulated using a Correlated Random Walk model (Kareiva & Shigesada, 1983; Carita et al. 2000;
 194 Codling et al. 2008; Ahearn et al. 2017). These models are based on a Markov process where
 195 consecutive changes in the animal's consecutive direction are correlated. For each time step Δt , the
 196 position of an individual at time t depends on its previous position at time $t-\Delta t$ and the turning angle
 197 α , defining the change in direction relative to the previous time step. Turning angles were randomly
 198 sampled from a normal distribution defined in the range $[-\pi; \pi]$, with zero mean and standard deviation
 199 σ following the method of Bovet & Benhamou (1988), using the `scipy.stats.truncnorm` python
 200 function. Standard deviation $\sigma = 0$ correspond to straight trajectories whereas in the limit $\sigma \rightarrow \infty$ the
 201 model converges to a simple random walk. In the following, σ was expressed in terms of the
 202 coefficient of sinuosity (c) according to the relationship, $\sigma = \sqrt{-2\ln(c)}$ with $c \in]0,1[$ (Bovet &
 203 Benhamou, 1988; Benhamou 2004). The limit $c \rightarrow 0$ corresponds to a simple random walk (highest
 204 sinuosity) whereas increasing c decreases the sinuosity, with straight trajectories for $c=1$. A total of 9
 205 coefficients of sinuosity were tested, ranging between 0.2 and 0.9999 (Table 2). Fig. 4 illustrates the
 206 distribution of turning angles and an example of a tuna trajectory for each coefficient of sinuosity
 207 tested.

208

209 **Table 2:** Model parameters that gives the 648 sets of parameters tested.

Parameters		Values
Tested parameters		
v	Speed (m/s)	0.7, 1.4
m	Rate of mortality (%/day)	0, 1, 2, 3, 4, 5
R_o	Orientation radius (km)	0, 2, 5, 10, 15, 20
c	Coefficient of sinuosity	0.2, 0.7, 0.9, 0.97, 0.99, 0.995, 0.997, 0.999, 0.9999
Fixed parameters		
Δt	Time step (s)	100
N	No. of simulated individuals	1000
T	Total duration (day)	38 (Mauritius), 120 (Hawaii)

210 In order to account for the orientation behavior of tuna towards FADs, different values of the
211 orientation radius were tested (Fig. 4, Table 2 and Supplementary Information 1). Each time a tuna
212 enters within this radius, its path changes to a straight trajectory oriented towards the FAD location.
213 If the tuna was located within the orientation radius of multiple FADs, a FAD was randomly selected
214 between them using a uniform distribution. A total of six orientation radii were tested, ranging
215 between 0 (no orientation) to 20 km, see Table 2. The diel rhythm in the associative behavior of tunas
216 was accounted for by defining two behavioral modes (“daytime” and “nighttime”) with a periodicity
217 of 24 hours each. During the 12 hours of “daytime” tuna displayed an orientation behavior towards
218 FADs (if located within the orientation radius). Conversely, during the 12 hours of “nighttime” tuna
219 did not exhibit a long-range attraction to FADs (no oriented behavior within the orientation radius)
220 and therefore followed a simple CRW dynamic. In both “daytime” and “nighttime” behavioral modes
221 a tuna was, however, considered to be associated with a FAD when it was located within 500 m of it.
222 This value is in accordance with both the observations of tuna when they were associated with FADs
223 (see Josse et al. 2000; Moreno et al. 2007), and the detection range of acoustic tags used in telemetry
224 studies around instrumented FADs (see Forget et al. 2015).

225 The model did not represent the association time of tuna at FADs (CRT), but these durations were
226 needed to compare the model with the field data. Therefore, the CRTs recorded from field data were
227 used as a model input. Each time a tuna reaches a FAD (i.e., it was located within 500 m of it), a CRT
228 value was randomly sampled from the actual CRT data of the corresponding array and the simulated
229 individuals do not move away from the FAD during the entire duration of the CRT. The CRTs recorded
230 from field data in each array are shown in the Supplementary Information 2. Once this time has
231 elapsed, individuals could leave the FAD in a random direction sampled from a uniform distribution
232 between $[-\pi; \pi]$. To avoid immediate returns, during the 24 hours following the end of a CRT, fish
233 was not affected by the association radius (R_o) of the FAD of departure. Similarly, returns due to
234 tuna re-entering the detection range within 24 hours (which were already taken into account in the
235 CRT duration) were neglected. For this purpose, each time a CAT_{return} of less than 24 hours was
236 recorded after a CRT, this movement was discarded and the simulation time was reset to the end of
237 the last CRT recorded (Fig. 3). This procedure ensured that CRT durations were consistent with field
238 data. Since the CRTs recorded immediately after tagging were significantly longer than the other
239 CRTs in the Hawaii field experiments and slightly longer in the Mauritius field data, (see
240 Supplementary Information 2) they were not considered in the above procedure. Accordingly, the
241 first CRT were also subtracted from the TRT to ensure data consistency.

242 Finally, a mortality rate (m) was considered to account for natural and fishing mortality events that
243 may cause the interruption of the acoustic detections for some tagged individuals. For this purpose, a
244 Monte Carlo algorithm was applied where, for each individual and at each time step, a random number

245 ε was sampled from a uniform distribution in the interval [0,1] and compared with the corresponding
 246 mortality rate using a Bernoulli test. A death was accepted for $\varepsilon < m \cdot T$. The constant T depends on
 247 the time step Δt and on the temporal units of the mortality rate. Different mortality rates were tested,
 248 ranging between 0 and 5% per day (Table 2). For a mortality rate expressed in days⁻¹ and Δt in
 249 seconds, $T = \Delta t / (3600 \times 24)$. The upper bound of 5% per day was estimated from survival analyses of
 250 field data (see Supplementary Information 3). TRTs values therefore depended on both the CRW
 251 dynamics (which affects the number of tuna associations, thus the time at which the last FAD
 252 detections occur) and the mortality rates (Fig. 2).

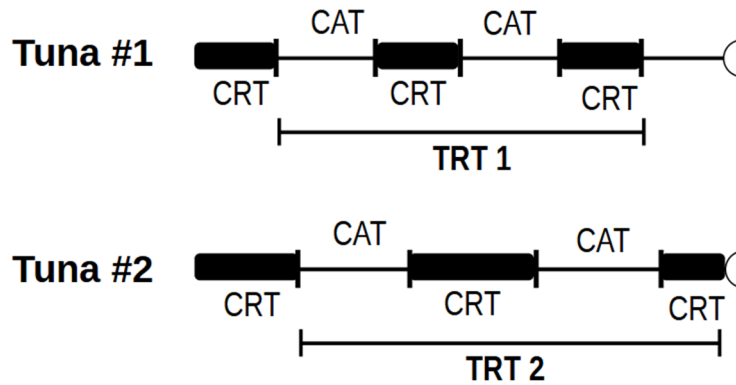

261 **Fig. 2:** Schematic diagram of behavioral sequences and Total Residence Time (TRT) definition. The
 262 tuna #1 presents a TRT ending at the end of the last Continuous Residence Time (CRT), recorded
 263 before the end of the experiment (indicated by a C-shape). The tuna #2 presents a TRT ending during
 264 a CRT because the experiment stopped, while the tuna was associated. CAT corresponds to
 265 Continuous Absence Times.

267 The model was run in a continuous unbounded space, centered around the actual FAD arrays of
 268 Mauritius and Hawaii. The topography of each island was considered using data from the R package
 269 “rworldmap” (South 2011). Each time simulated individuals were at risk of crossing island
 270 boundaries, the distribution of turning angles α was sub-sampled in order to avoid the island.
 271 A total of 1000 individuals were considered in each FAD array, for each combination of model
 272 parameters. For each individual, the simulations started at one of the FADs of tagging, in order to
 273 reproduce the experimental design as accurately as possible. The probability to start at a given FAD
 274 was obtained considering the number of tuna tagged at the FAD, relative to the total number of tuna
 275 tagged in the field experiment (see Supplementary Information 4). Two different swimming speeds
 276 were tested: 0.7 and 1.4 m/s, corresponding to one and two body-lengths per second respectively (see
 277 swimming speeds in Girard et al. 2004 and tagging studies used in this study: Robert et al. 2013 and
 278 Rodriguez-Tress et al. 2017). Time steps (Δt) lasted 100 s and each resulted in individual fish
 279 movements of 70 and 140 m depending on the speed.

280 A summary of all model parameters can be found in Table 2. All the simulations were performed
 281 using the Python 3 programming language (Python Software Foundation, version 3.8.5).

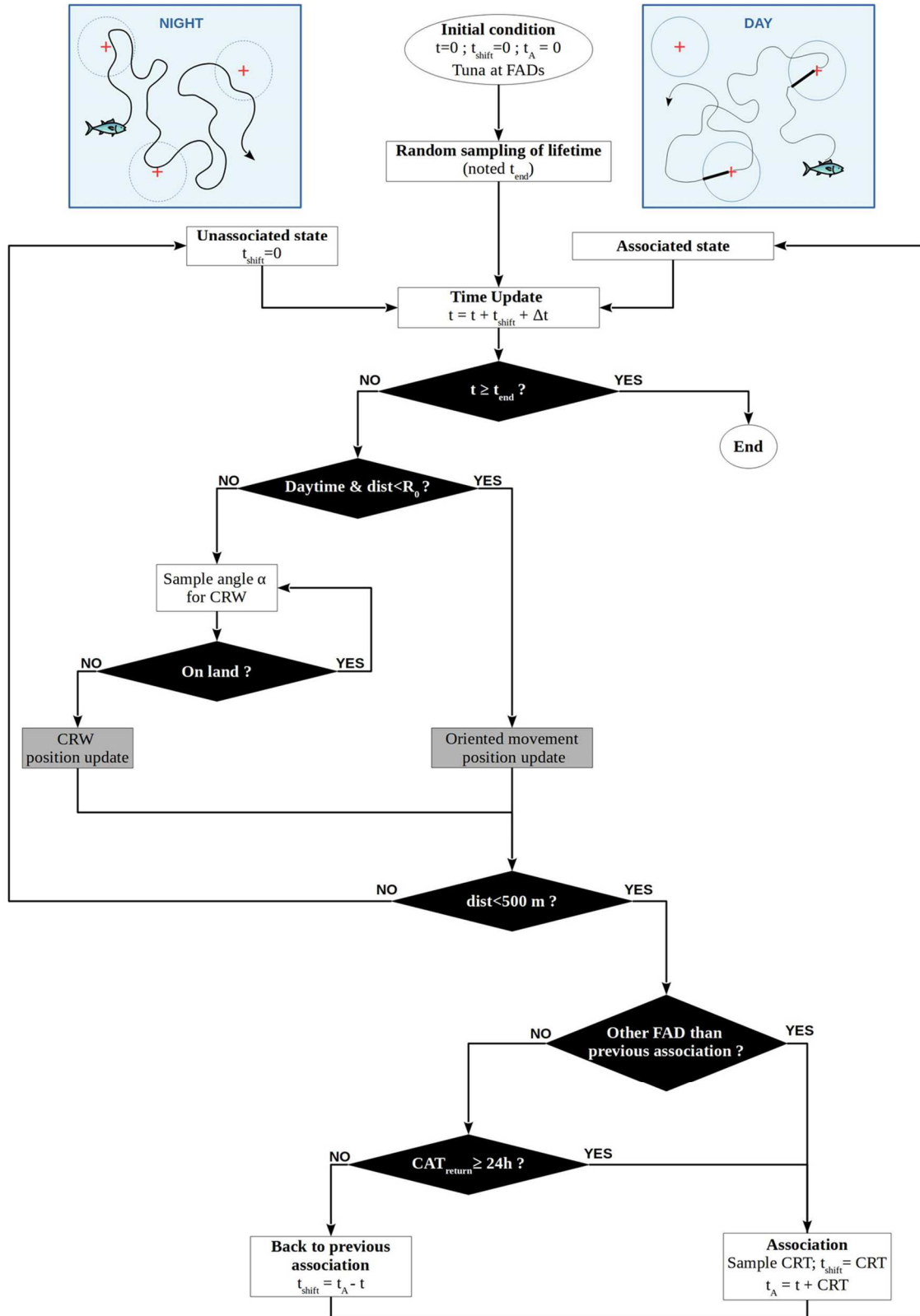

282 **Fig. 3:** Flow-Chart diagram illustrating the model algorithm. CRW denotes Correlated Random
 283 Walk, R_0 corresponds to the orientation radius, $dist$ corresponds to the distance between the tuna and

284 the closest Fish Aggregating Device (FAD) and the value t_{end} takes into account the death of tuna as
 285 well as the end of the experimentation.

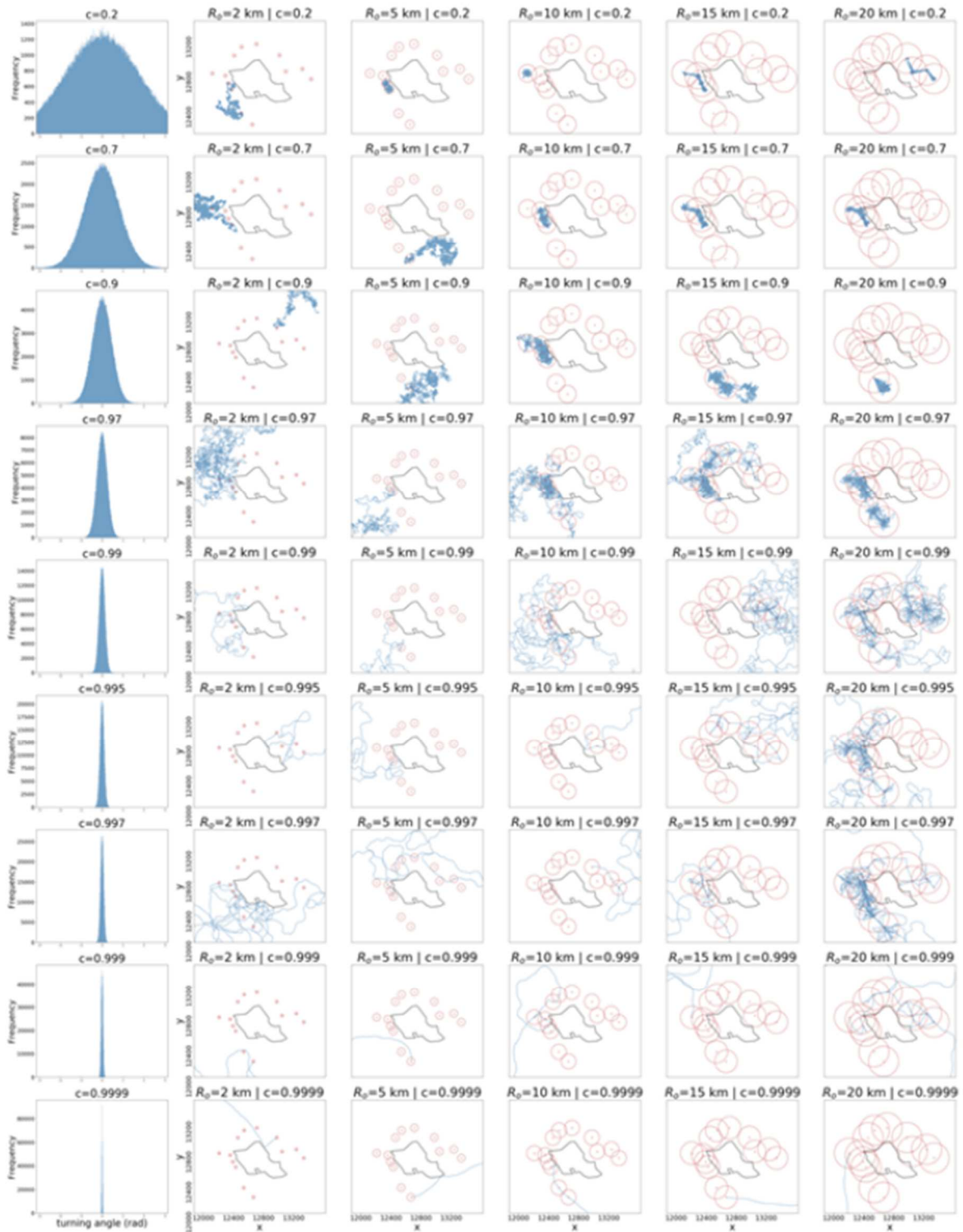

286
 287 **Fig. 4:** Example of tuna path trajectories according to the coefficient of sinuosity (c ; rows) and the
 288 orientation radius (R_o , columns) tested for the Hawaiian array. The first column shows the
 289 distribution of turning angles (α in radians) for each coefficient of sinuosity tested. The orientation
 290 radii are represented by red circles centered around each FAD and the case $R_o=0$ is not represented.
 291 For the Mauritian array, see Supplementary Information 2.

292

293 **2.4. Comparison between simulated and field data**

294 Since the model aimed at fitting the time that tuna spent between two FAD associations (CAT_{diff}), the
295 comparison between the model and the field data focused on this metric. However, the distribution of
296 CAT_{diff} also depends on the total time spent in the FAD array (i.e. longer CAT_{diff} can only be observed
297 for longer TRT). As such, the comparison between the model and the field data was performed for
298 both metrics. For this purpose, CAT_{diff} and TRT were obtained from the simulated data using the same
299 procedures applied to the field data. The selection of model parameters which best fitted the field data
300 was made using a survival analysis, by comparing the theoretical survival curves of the TRT and the
301 CAT_{diff} with those obtained from field data, through a bootstrap method. Experimental survival curves
302 $S(t)$ were constructed (Capello et al. 2015), which represented the proportion of events (TRT or
303 CAT_{diff}) longer than a given duration t . For each set of parameters the survival curve of the field data
304 was compared 1000 times with a sub-sample of the same size as the field data, *i.e.* 56 individuals for
305 Hawaii and 14 for Mauritius (Table 1), randomly sampled from the 1000 simulated individuals. For
306 each of the bootstrap sample, survival curves obtained from the simulated and field data were
307 compared using Cox proportional hazards regressions. The statistical significance of the model was
308 assessed using the p-value from a logrank test, which tested the null hypothesis of identical hazards
309 between the model and the field data. For each survival curve (TRT and CAT_{diff}) and FAD array
310 (Mauritius and Hawaii), the percentage of retained bootstrap tests was calculated, corresponding to
311 the number of bootstrap tests showing p-values > 0.05 over the 1000 tests performed. Finally, each set
312 of parameters was assigned the lower percentage of retained bootstraps estimated over survival curves
313 (TRT and CAT_{diff}) and FAD arrays (Hawaii and Mauritius).

314 The Cox proportional hazards regressions and logrank tests were performed using the R software (R
315 Core Team 2018 version 3.4.4) with the function “coxph” in the “survival” package version 3.1-8
316 (Therneau & Grambsch 2000).

317

318

319

320

321

322

323

324

325

326

327 **3. Results**

328 A total of 648 sets of parameters were tested (Table 2), of which 7 appeared to best fit both the CAT_{diff}
329 and TRT recorded in the Mauritian and Hawaiian arrays considering a percentage of retained
330 bootstrap tests $\geq 85\%$ (Table 3 and Supplementary Information 5). That is, over the 1000 tests
331 performed for each set of parameters, 7 sets were not statistically different from the field data in more
332 than 85% of the tests performed on both survival curves (TRT and CAT_{diff}) and FAD arrays (Mauritius
333 and Hawaii). Fig. 5 and Fig. 6 present the CAT_{diff} and TRT survival curves for each FAD array, for
334 the two sets of parameters performing the best.

Table 3: Set of retained model parameters for which more than 85% of the bootstrap tests fit the field data. .

v (m/s)	m (%/day)	R_0 (km)	c	Retained Bootstraps (%)
0.7	2	5	0.99	91.5
1.4	2	2	0.97	90.7
1.4	3	2	0.9	89.8
0.7	2	5	0.995	89.7
1.4	4	2	0.9	89.4
1.4	2	2	0.9	87.5
0.7	3	5	0.99	86.6

335

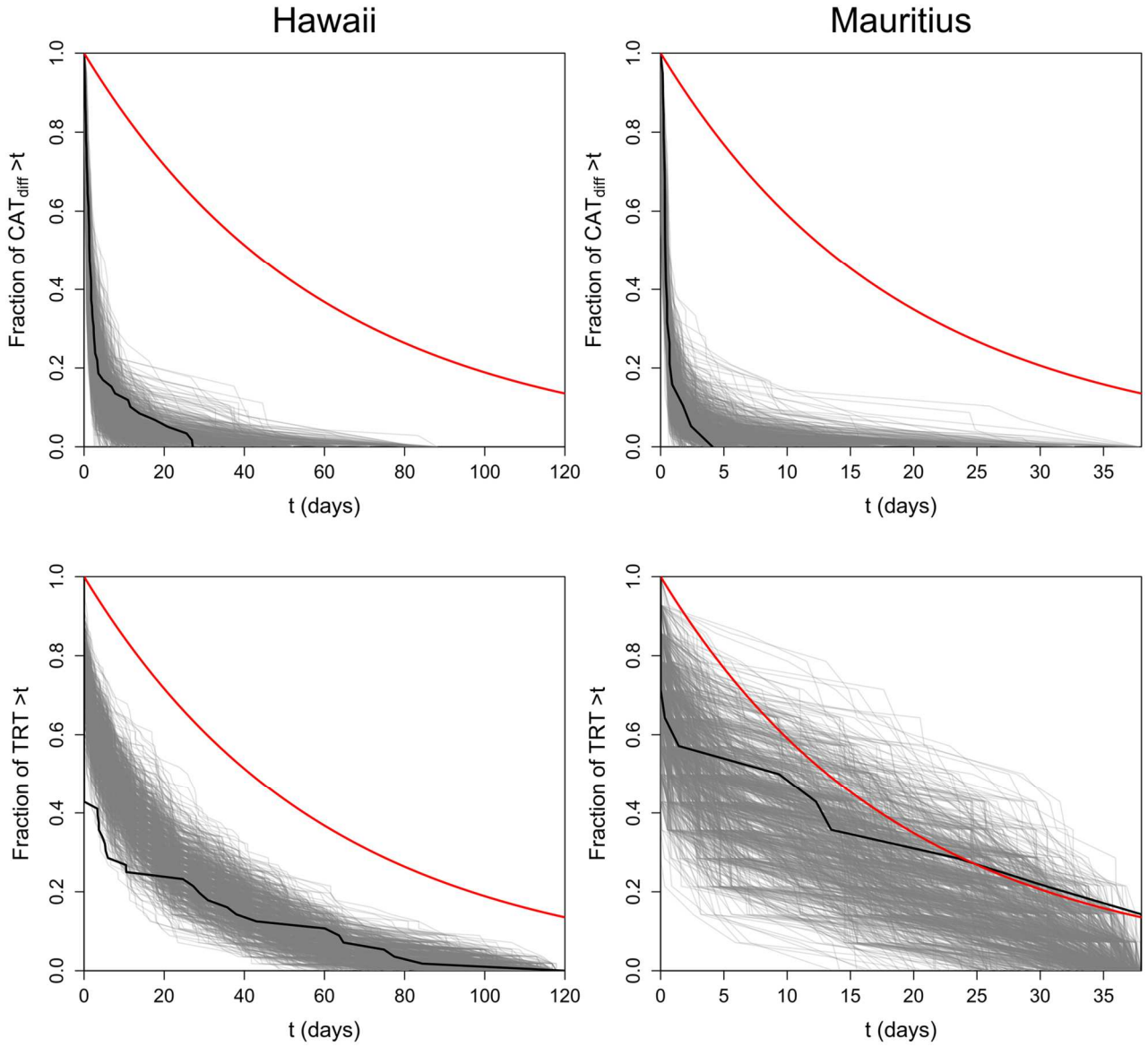

336 **Fig. 5.:** Comparison of survival curves obtained from field data (black) and from the 1000 bootstrap
 337 samples (gray) for a speed $v=0.7 \text{ m s}^{-1}$, a mortality $m=2\%$, a orientation radius $R_o=5 \text{ km}$ and a
 338 coefficient of sinuosity $c=0.99$ (with % retained bootstrap = **91.5%**, see Table 3). The first row
 339 corresponds to the survival curves of CAT_{diff} (A and B) and the second row to the TRT (C and D). The
 340 first column denotes the Hawaiian FAD array (A and C) and the second column the Mauritian array
 341 (B and D). The red line corresponds to the theoretical curve ($\exp(-mt)$) representing the upper bound
 342 of TRT.

343

344

345

346

347

348

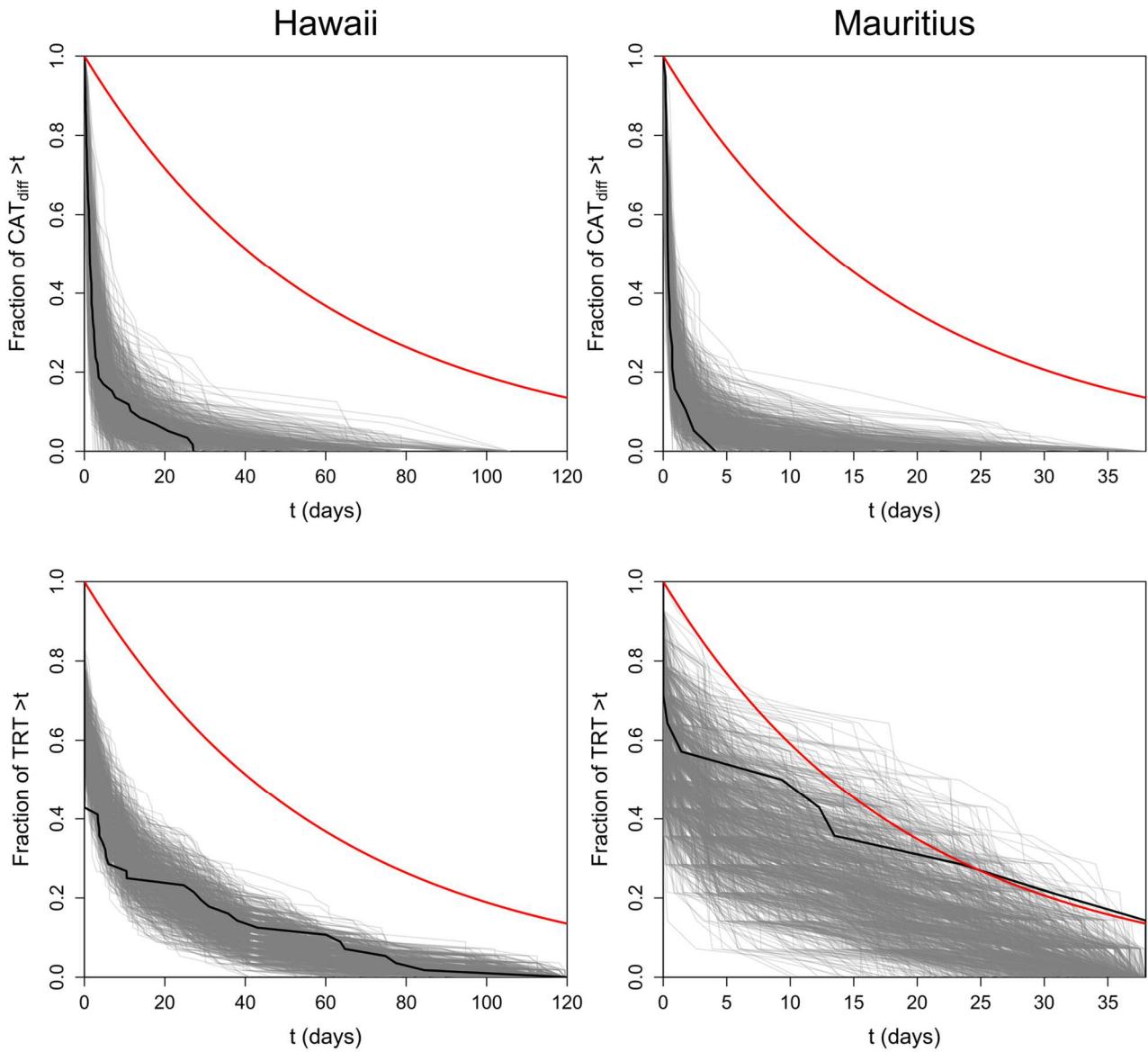

349 **Fig. 6:** Comparison of survival curves obtained from field data (black) and from the 1000 bootstrap
 350 samples (gray) for a speed $v=1.4 \text{ m s}^{-1}$, a mortality $m=2\%$, a orientation radius $R_o=2 \text{ km}$ and a
 351 coefficient of sinuosity $c=0.97$ (with % retained bootstrap = **90.7%**, see Table 3). The first row
 352 corresponds to the survival curves of CAT_{diff} (A and B) and the second row to the TRT (C and D). The
 353 first column denotes the Hawaiian FAD array (A and C) and the second column the Mauritian array
 354 (B and D). The red line corresponds to the theoretical curve ($\exp(-mt)$) representing the upper bound
 355 of TRT.

356

357

358 The complete results of the bootstrap test are available in Supplementary Information 6. Any speed
 359 values between the tested ones (0.7 and 1.4 m/s) will reflected the field behavior (Fig. 7 and
 360 Supplementary Information 7). In the same way, all values of the mortality rate can be retained.
 361 However, null mortalities ($m=0$), showed poorer bootstrap results (higher percentage of retained
 362 bootraps of 62.2%, see Fig. 7, Supplementary Information 6 and 7). Similarly, mortality rates of 5%

363 and 1% did not appear among the 7 best fits (Table 3). However, combinations of parameters exist
 364 with high percentages of retained bootstraps (83.5% for $m=5\%/day$ and 80.1% for $m=1\%/day$, see
 365 Fig. 7, Supplementary Information 6 and 7). On the opposite, orientation radii of 2 and 5 km clearly
 366 stand out (Fig. 7 and Supplementary Information 7)), all the other values having a percentage of
 367 retained bootstraps below 55% (Fig. 7, Supplementary Information 6) and even below 20% for
 368 orientation radii of 15 and 20 km (Fig. 7, Supplementary Information 6). Finally, the coefficients of
 369 sinuosity (c) performing the best range from 0.9 to 0.995 (all with a percentage of retained bootstraps
 370 above 80%, Fig. 7, Supplementary Information 6 and 7). Coefficients of $c=0.2$, 0.999 and 0.9999
 371 showed poorer results (percentage of retained bootstraps respectively 37.2%, 51.3% and 7%, see Fig.
 372 7, Supplementary Information 6 and 7).

373

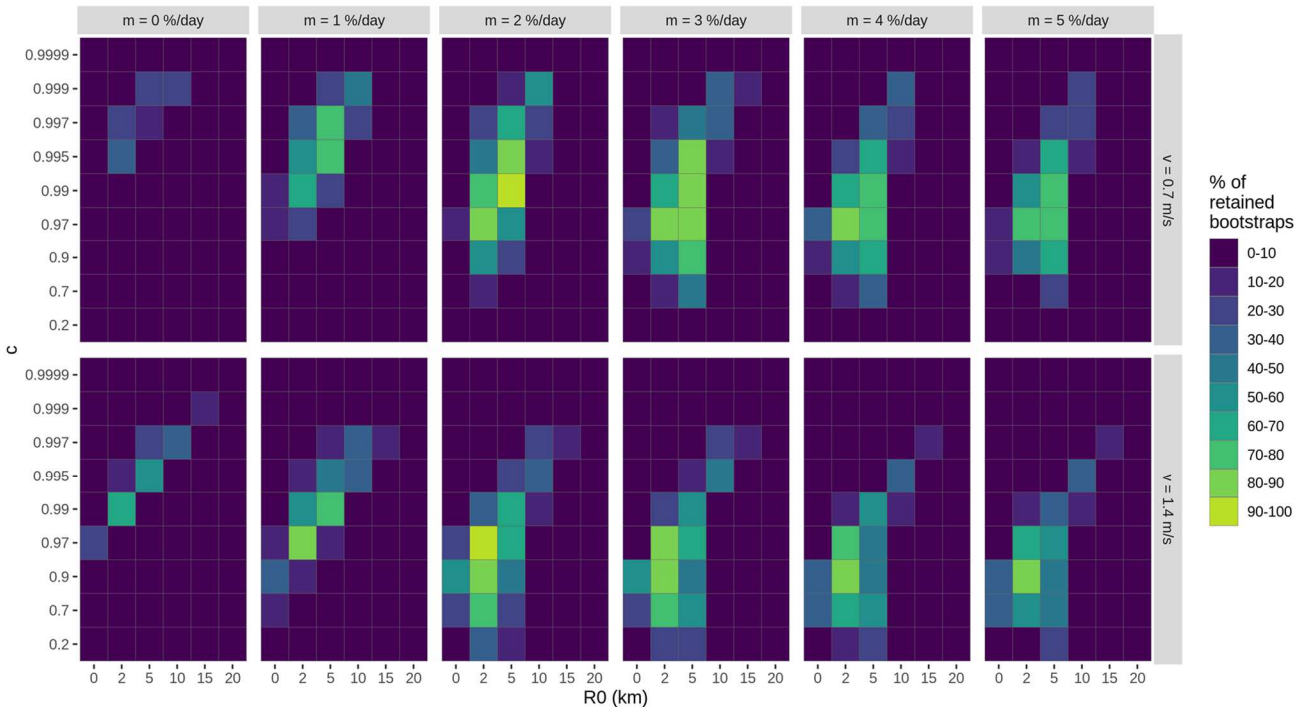

374 **Fig. 7:** Heatmap of the percentage of retained bootstraps that fit the field data for each set of model
 375 parameters. Rows corresponds to the tested speeds (v), columns denote the mortality rates (m). Tested
 376 values of the orientation radius (R_0) are shown in the x-axis and tested coefficients of sinuosity (c) in
 377 the y-axis.

378

379 4. Discussion

380 The study of animal behavior made considerable progress in the last decades, thanks to the
 381 development of electronic tagging and camera trapping technologies (Swann & Perkins, 2014;
 382 Hughey et al. 2018). However, characterizing the movement of animals in their own environment still
 383 remains a challenging task, particularly in marine environments, where GPS technologies can rarely

384 be used. Here, through the use a field-based modeling approach and passive acoustic telemetry data,
385 we provide, for the first time, a method for describing the movement behavior of tunas in FAD arrays.
386 The model is built upon four main behavioral components, based on the state-of-the-art knowledge
387 of the associative dynamics of tunas at FADs: random walk dynamics, orientation capabilities, diel
388 behavior and a lack in correlation between the duration of consecutive CRTs and CATs. A relatively
389 small number of parameters drive the model's properties: swimming speed, path sinuosity, orientation
390 radius and mortality rate. Despite the model's structural simplicity and the reduced number of
391 parameters, it was able to reproduce both of the investigated movement metrics (time between two
392 FAD associations and total time spent in the array) in two different FAD arrays.

393 The four parameters tested can be related to the physiological capabilities and condition of tuna, as
394 well as their environment (including the FADs, other tuna and non-tuna species present in the array).
395 The two swimming speeds tested (corresponding to the 0.7 and 1.4 m/s) stem from previous studies
396 showing that swimming speed typically range between 1 and 2 body lengths per second (Girard et
397 al., 2004; Dagorn et al. 2013b). In contrast, despite previous evidences of a random walk behavior in
398 tuna movements between FADs (Girard et al. 2004; Pérez et al. 2020), no empirical studies have
399 estimated the sinuosity of a tuna path in a FAD array. As a consequence, large ranges of sinuosity
400 were considered. The results show that, while both speed values could be retained by the simulations,
401 only a limited subset of sinuosity coefficients emerged. The majority of sinuosity coefficients that
402 were retained indicated a rather skewed distribution of turning angles (Fig. 3, Table 3). Lower
403 sinuosity coefficients were mostly found for the highest swimming speed (Table 3). This is to be
404 expected considering that for a given average distance traveled during a correlated random walk,
405 higher speeds imply lower sinuosity coefficients and vice-versa (Hall 1977; Kareiva & Shigesada
406 1983; Marsh & Jones 1988). Hence, the values of the sinuosity coefficient (c) retained are valid
407 considering the chosen time step ($\Delta t=100$ s). It is likely that the tuna movement characteristics (speed
408 and sinuosity) also depend on the fine-scale environmental characteristics within the FAD array, such
409 as the type and distribution of prey, or the physiological conditions of the tuna itself. In future, the
410 consideration of a range of swimming speeds and path sinuosity, as opposed to single values, could
411 provide a more realistic picture of tuna movements. However, the range of values used in this study
412 provides an initial set of movement characteristics that are compatible with field observations, thus
413 contributing to the poorly understood dynamics of tuna in a FAD array.

414 The mortality rate (which accounts for both natural and fishing mortality) is primarily influenced by
415 risks associated with fishing activity, natural predation and disease. A previous study using
416 conventional tags from the Hawaii Tuna Tagging Project (HTTP) showed a natural mortality rate of
417 0.36% per day and a fishing mortality of 0.67 % per day for yellowfin tuna larger than 56 cm (Adam
418 et al. 2003). As such, the global mortality rates estimated through our simulations appear to be higher

419 than previous findings. This difference could be due to a specific mortality in each study site and
420 period considered. Indeed, even if in both cases the Hawaiian archipelago was considered, these
421 studies concern different islands and study periods, for which the fishing pressure might differ as well
422 as the natural mortality.

423 Acoustic telemetry data do not allow for the direct estimation of mortality rate, but do provide
424 information on the time at which an individual is no longer detected by receivers deployed on FADs.
425 Generally, a lack of acoustic detections indicates that tuna have either left the FAD array or died.
426 Movement dynamics of tuna can explain the first potential causes for a lack of detection. Within the
427 model, the propensity of an individual to depart from the array is directly linked to the sinuosity of
428 its path, its swimming speed and its orientation radius. For instance, large path sinuosity (resulting
429 from small values of the sinuosity coefficient c) primarily leads to movements close to the FAD of
430 departure and little or no detections at the other FADs. Conversely, small path sinuosity (from high
431 values of the coefficient of sinuosity c) generally results in individuals rapidly leaving the array (Fig.
432 3 and Supplementary Information 1). In this way, the model provides direct information on the rate
433 at which tuna are lost from FAD arrays. Fitting the model to the field data allows for differentiation
434 between loss through randomness of movement and loss due to mortality (Table 2 and Supplementary
435 Information 3). As such this field-based movement model could provide a new and alternative
436 methodology for estimating the mortality rates of tuna in a FAD array.

437 In the model, the orientation radius represents the distance from which tunas are able to orient
438 themselves towards FADs, while on the field tuna could be able to perceive FADs before
439 orienting themselves toward them. No data is available on the distance at which tunas perceive FADs,
440 but tuna movements provide input on the distance at which tunas start to orient themselves toward
441 FADs. Therefore, the FAD perception radius was not considered in this study. This distance naturally
442 depends on the tuna's ability to perceive its surrounding environment, as well as on the physical
443 characteristics of the area. Given the large distances from which tuna can orient themselves towards
444 FADs, highlighted in previous studies (Girard et al. 2004), as well as those found in this study, the
445 use of visual cues as explanatory factors can be discarded. As sound can travel great distances
446 underwater, the perception of acoustic stimuli could be a valid hypothesis for explaining the ability
447 of tunas to orient towards FADs from such large distances. Environmental characteristics may impact
448 the propagation of sounds between FADs and tunas and influence how strong these sound stimuli are.
449 The physical characteristics of the water mass are known to affect the propagation of sound waves
450 (Lee et al. 2017; Siddiqui & Dong 2019). Furthermore, the topology of the FAD array and its location
451 relative to the coastline could also affect underwater sound propagation. As sounds may be produced
452 by the FAD structures themselves, they can vary depending on the materials used and the design of
453 each structure, which often differ among FAD arrays. Although FAD design has not been identified

454 as influencing the attractiveness of FADs (Fréon & Dagorn 2000), it may impact their detectability.
455 Tunas may also perceive the presence of a FAD through the emission of noise generated by the fish
456 aggregation itself. In such a situation the intensity of the noise could be dependent on the quantity of
457 fish present, but also on the types of species and their activities. Considering these multiple potential
458 sources of environmental variability, the distance at which tuna are able to perceive FADs (orientation
459 radius) is likely to vary both within and between FAD arrays. No single value of the orientation radius
460 can exist, but rather a distribution of these distances with a subset of values for which the probability
461 of being located in the environment is greatest. A general model that describes the movements of tuna
462 in different FAD arrays with the same parameters, such as the one developed in this study, provides
463 a subset of the most probable orientation distances. However, it is likely that a distribution of
464 orientation distances could be more realistic and for a particular FAD, the orientation radius could
465 have its own dynamics according to local environmental conditions.

466 A previous study by Girard et al. (2004) determined orientation radii between 4 and 17 km, with a
467 mode around 10 km. This study was based on 14 yellowfin tuna (YFT) from 47 cm to 167 cm FL,
468 that were acoustically tracked in different FAD arrays (Holland et al., 1990; Marsac & Cayré, 1998;
469 Brill et al. 1999; Dagorn et al. 2000) and included the specie-size category considered in our
470 simulations (YFT of ~70 cm). These 14 individuals were actively tracked over short durations,
471 between 12 and 86 hours (due to the constraints of active tracking) rather than passively monitored
472 as in our study. The radii found in our 7 sets of parameters (5 km and 2 km in one set) are similar to
473 the lower range of the orientation distances (4-17 km) found by Girard et al. (2004). The longer
474 orientation distances identified in that study could be attributed to the inclusion of only long paths
475 (more than 7 km away from the FADs) in their analysis. Furthermore, the authors considered that the
476 longest orientation distances (e.g. > 15 km) could be the result of tuna patrolling along the coast, thus
477 using some bathymetric information rather than signals from FADs. As such, the distances found by
478 Girard et al. (2004) may represent maximum orientation distances, while the average could be shorter,
479 and more similar to the values we found (2-5 km).

480 Finally, it is important to note that the two studies considered different datasets collected in different
481 regions, and possible inter-FAD array variability in the orientation radius cannot be excluded. It is
482 important to stress that the retention of the model parameters was very conservative: only those valid
483 for both metrics (TRT and CATdiff) and FAD arrays were kept. In doing so, possible local variability
484 in tuna behavior (for example, a different orientation radius depending on the study site) were
485 excluded. This choice was made to obtaining the minimal, and most general model, that could
486 reproduce the observations. Considering a threshold of 85% for the percentage of retained bootstraps
487 provides 7 sets of parameter values over the 648 tested. These values (radius of orientation ranging
488 between 2-5 km, coefficient of sinuosity between 0.9 and 0.995, mortality rates between 2 and 3%)

489 provide the main characteristics of tuna movements in FAD arrays. To avoid any scaling issue, the
490 same data treatment was applied to both field and simulated data sets. Therefore, the model can be
491 considered to correctly reproduce the tuna movements between FADs at the dayscale, i.e., the scale
492 related to a maximum blanking period of 24h (Capello et al. 2015), which was used to process the
493 acoustic data. Further studies, across a greater number of study sites, could provide insight into how
494 these model parameters could vary between FAD arrays. Similarly, it would be of interest to consider
495 how this model, fitted for YFT-70, is able to describe the behavior of other tuna species and sizes.
496 This model could also be used for other non-tuna species that associate with FADs and in particular
497 vulnerable species such as the silky sharks (*Carcharhinus falciformis*).

498
499 As this model aimed to simulate tuna movements in FAD arrays, the time tuna spent associated with
500 FADs (CRT) was not simulated and the experimental CRT distribution was used as an input of the
501 model. Further model developments, which consider social interactions at FADs (Robert et al. 2014;
502 Pérez et al. 2020), may allow the CRT durations within different FAD arrays to also be integrated into
503 the model. This integration of CRTs into the model would involve adding social interactions between
504 individuals and behavioral rules of social retention at the FAD that follow the meeting point
505 hypothesis (Dagorn & Fréon 1999, Fréon & Dagorn, 2000, Robert et al. 2014).

506

507 **5. Conclusion**

508 Building on current knowledge of the associative behavior tuna at FADs from acoustic telemetry data,
509 our model is the first to reproduce the movement behavior of tunas in a FAD array. A total of 7 sets
510 of parameters (Table 3) were able to reproduce, with a high confidence, the movements of yellowfin
511 tuna (fork length 70 cm) in two different FAD arrays, suggesting the model is robust. Future model
512 improvements could consider distributions of speeds, sinuosity, detection radii and mortality rates
513 (rather than fixed values) which may provide a better reflection of the variability induced by the local
514 environment and the physiological conditions of the tuna themselves.

515 This model can be used on all species that display associative behavior with floating object. This
516 includes species such as dolphinfish (*Coryphaena hippurus*) or the vulnerable silky shark
517 (*Carcharhinus falciformis*). When combined with acoustic telemetry data, the model can provide an
518 alternative method for determining the mortality rate of tuna and other associated species in a FAD
519 array. Given the difficulty in assessing natural and fishing mortality for wild marine species, this
520 novel approach could be of interest for the stock assessment community. Moreover, the model could
521 be used to predict how increasing numbers of FADs affect the ecology of tunas ecology, both in terms
522 of the time spent away from FADs and the total time spent in a FAD array. This study offers a new
523 tool to provide science-based advice for the management of FAD fisheries, since the more time fish

524 spend associated, the more vulnerable these individuals are to the fishery. Scenarios could be extended
525 to drifting FADs in open ocean areas, as both anchored and drifting FADs alter the environment in a
526 similar way (Dagorn et al. 2010). While acoustic telemetry experiments have successfully
527 characterized residence times at drifting FADs (Govinden et al. 2010; Forget et al. 2015), measuring
528 in situ absence times of tunas within drifting FAD arrays is a major research challenge and these
529 parameters are key for the development of robust FAD management plans by Tuna Regional Fisheries
530 Management Organisations (RFMOs). Our model provides a method for estimate these parameters
531 in the absence of data from acoustically tagged tuna in drifting FAD arrays.

532 Finally, the same approach can be used to study the movement behavior of other marine and terrestrial
533 species that manifest an associative behavior with aggregating sites, and for which presence/absence
534 data are recorded at these sites. For instance, our model could be used to study the movements of
535 terrestrial animals who show associative behaviors with waterholes (Zvidzai et al. 2013; O’Farrill et
536 al. 2014) detected through camera traps (Swann & Perkins, 2014; Hughey et al. 2018.). More
537 generally, this method could be used even without any associative behavior at specific sites, as long
538 as the study site is equipped with regularly spaced and sufficiently numerous receivers where
539 individuals can be identified.

540

541 **Data Availability Statement**

542 Simulations were performed with the model FAT albaCoRaW v1.3. All scripts and data used in this
543 study are available on GitHub (https://github.com/adupaix/FAT_albaCoRaW, doi:
544 10.5281/zenodo.5834056.).

545

546 **Acknowledgements**

547 The authors would like to acknowledge the two anonymous reviewers for their extensive and
548 constructive feedback.

549

550 **Funding**

551 This project was co-funded by the ANR project BLUEMED (ANR-14-ACHN-0002), “Observatoire
552 des Ecosystèmes Pélagiques Tropicaux exploités” (Ob7) from IRD/MARBEC and by the
553 International Pole-and-line Foundation (IPNLF).

554

555 **Authors' contributions**

556 SB, KH and LD collected the raw data in the field. GP developed the model, with major contribution
557 of AD and MC. GP analysed the data and wrote the paper with major contribution of MC, LD, JLD
558 and AD. All authors read and approved the final manuscript.

560 **Bibliography**

- 561 Adam, M. S., Sibert, J., Itano, D., & Holland, K. (2003). Dynamics of bigeye (*Thunnus obesus*) and
 562 yellowfin (*T. albacares*) tuna in Hawaii's pelagic fisheries: Analysis of tagging data with a bulk
 563 transfer model incorporating size-specific attrition. *Fishery Bulletin*, *101*(2), 215–228.
- 564 Ahearn, S. C., Dodge, S., Simcharoen, A., Xavier, G., & Smith, J. L. D. (2017). A context-sensitive
 565 correlated random walk: a new simulation model for movement. *International Journal of*
 566 *Geographical Information Science*, *31*(5), 867–883.
 567 <https://doi.org/10.1080/13658816.2016.1224887>
- 568 Benhamou, S. (2004). How to reliably estimate the tortuosity of an animal's path: Straightness,
 569 sinuosity, or fractal dimension? *Journal of Theoretical Biology*, *229*(2), 209–220.
 570 <https://doi.org/10.1016/j.jtbi.2004.03.016>
- 571 Bovet, P., & Benhamou, S. (1988). Spatial analysis of animals' movements using a correlated
 572 random walk model. *Journal of Theoretical Biology*, *131*(4), 419–433.
 573 [https://doi.org/10.1016/S0022-5193\(88\)80038-9](https://doi.org/10.1016/S0022-5193(88)80038-9)
- 574 Brill, R. W., Block, B. A., Boggs, C. H., Bigelow, K. A., Freund, E. V., & Marcinek, D. J. (1999).
 575 Horizontal movements and depth distribution of large adult yellowfin tuna (*Thunnus albacares*)
 576 near the Hawaiian Islands, recorded using ultrasonic telemetry: implications for the
 577 physiological ecology of pelagic fishes. *Marine Biology*, *133*, 395–408.
 578 <https://doi.org/10.1007/s002270050478>
- 579 Byers, J. A. (2001). Correlated random walk equations of animal dispersal resolved by simulation.
 580 *Ecology*, *82*(6), 1680–1690. [https://doi.org/10.1890/0012-](https://doi.org/10.1890/0012-9658(2001)082[1680:CRWEOA]2.0.CO;2)
 581 [9658\(2001\)082\[1680:CRWEOA\]2.0.CO;2](https://doi.org/10.1890/0012-9658(2001)082[1680:CRWEOA]2.0.CO;2)
- 582 Capello, M., Robert, M., Soria, M., Potin, G., Itano, D., Holland, K., ... Dagorn, L. (2015). A
 583 methodological framework to estimate the site fidelity of tagged animals using passive
 584 acoustic telemetry. *PLoS ONE*, *10*(8), 1–19. <https://doi.org/10.1371/journal.pone.0134002>
- 585 Carita M., B., James A., S., & S.N., L. (2000). Caribou movement as a correlated random walk.
 586 *Oecologia*, *123*, 364–374.
- 587 Castro, J., Santiago, J., & Santana-Ortega, T. (2002). A general theory on fish aggregation to
 588 floating objects: An alternative to the meeting point hypothesis. *Reviews in Fish Biology and*
 589 *Fisheries*, *11*, 255–277. <https://doi.org/10.1023/A:1020302414472>
- 590 Codling, E. A., Plank, M. J., & Benhamou, S. (2008). Random walk models in biology. *Journal of*
 591 *the Royal Society Interface*, *5*(25), 813–834. <https://doi.org/10.1098/rsif.2008.0014>
- 592 Cramer, A., Katz, S., Kogan, C., & Lindholm, J. (2021). Distinguishing residency behavior from
 593 random movements using passive acoustic telemetry. *Marine Ecology Progress Series*, *672*,
 594 73–87. <https://doi.org/10.3354/meps13760>
- 595 Dagorn, L., & Fréon, P. (1999). Tropical tuna associated with floating objects: a simulation study of
 596 the meeting point hypothesis. *Canadian Journal of Fisheries and Aquatic Sciences*, *56*(6),
 597 984–993. <https://doi.org/10.1139/cjfas-56-6-984>

- 598 Dagorn, L., Holland, K. N., Restrepo, V., & Moreno, G. (2013a). Is it good or bad to fish with
 599 FADs? What are the real impacts of the use of drifting FADs on pelagic marine ecosystems?
 600 *Fish and Fisheries*, 14(3), 391–415. <https://doi.org/10.1111/j.1467-2979.2012.00478.x>
- 601 Dagorn, L., Bez, N., Fauvel, T., & Walker, E. (2013b). How much do fish aggregating devices
 602 (FADs) modify the floating object environment in the ocean? *Fisheries Oceanography*, 22(3),
 603 147–153. <https://doi.org/10.1111/fog.12014>
- 604 Dagorn, L., Holland, K. N., & Filmalter, J. D. (2010). Are drifting FADs essential for testing the
 605 ecological trap hypothesis? *Fisheries Research*, 106(1), 60–63.
 606 <https://doi.org/10.1016/j.fishres.2010.07.002>
- 607 Dagorn, L., Holland, K. N., & Itano, D. (2007). Behavior of yellowfin (*Thunnus albacares*) and
 608 bigeye (*T. obesus*) tuna in a network of fish aggregating devices (FADs). *Marine Biology*,
 609 151(2), 595–606. <https://doi.org/10.1007/s00227-006-0511-1>
- 610 Dagorn, L., Holland, K. N., Restrepo, V., & Moreno, G. (2013). Is it good or bad to fish with FADs?
 611 What are the real impacts of the use of drifting FADs on pelagic marine ecosystems? *Fish and*
 612 *Fisheries*, 14(3), 391–415. <https://doi.org/10.1111/j.1467-2979.2012.00478.x>
- 613 Dagorn, L., Josse, E., Bach, P., & Bertrand, A. (2000). Modeling tuna behaviour near floating
 614 objects: From individuals to aggregations. *Aquatic Living Resources*, 13(4), 203–211.
 615 [https://doi.org/10.1016/S0990-7440\(00\)01065-2](https://doi.org/10.1016/S0990-7440(00)01065-2)
- 616 Dempster, T., & Taquet, M. (2004). Fish aggregation device (FAD) research: Gaps in current
 617 knowledge and future directions for ecological studies. *Reviews in Fish Biology and Fisheries*,
 618 14(1), 21–42. <https://doi.org/10.1007/s11160-004-3151-x>
- 619 Elzhov T.V., Mullen K. M., Spiess, A-N., & Bolker, B. (2016). minpack.lm: R Interface to the
 620 Levenberg-Marquardt Nonlinear Least-Squares Algorithm Found in MINPACK, Plus
 621 Support for Bounds. R package version 1.2-1. [https://CRAN.R-](https://CRAN.R-project.org/package=minpack.lm)
 622 [project.org/package=minpack.lm](https://CRAN.R-project.org/package=minpack.lm)
- 623 Forget, F., Capello, M., Filmalter, J. D., Govinden, R., Soria, M., Cowley, P. D., & Dagorn, L.
 624 (2015). Behaviour and vulnerability of target and non-target species at drifting fish aggregating
 625 devices (FADs) in the tropical tuna purse seine fishery determined by acoustic telemetry.
 626 *Canadian Journal of Fisheries and Aquatic Sciences*, 72(9), 1398–1405.
 627 <https://doi.org/10.1139/cjfas-2014-0458>
- 628 Fréon, P., & Dagorn, L. (2000). Review of fish associative behaviour: Toward a generalisation of
 629 the meeting point hypothesis. *Reviews in Fish Biology and Fisheries*, 10(2), 183–207.
 630 <https://doi.org/10.1023/A:1016666108540>
- 631 Girard, C., Benhamou, S., & Dagorn, L. (2004). FAD: Fish Aggregating Device or Fish Attracting
 632 Device? A new analysis of yellowfin tuna movements around floating objects. *Animal*
 633 *Behaviour*, 67(2), 319–326. <https://doi.org/10.1016/j.anbehav.2003.07.007>
- 634 Girard, C., Dagorn, L., Taquet, M., Aumeeruddy, R., Peignon, C., & Benhamou, S. (2007). Homing
 635 abilities of dolphinfish (*Coryphaena hippurus*) displaced from fish aggregating devices (FADs)
 636 determined using ultrasonic telemetry . *Aquatic Living Resources*, 321(2007), 313–321.
 637 <https://doi.org/10.1051/alr:2008005>

- 638 Govinden, R., Capello, M., Forget, F., Filmalter, J. D., & Dagorn, L. (2021). Behavior of skipjack
639 (*Katsuwonus pelamis*), yellowfin (*Thunnus albacares*), and bigeye (*T. obsesus*) tunas
640 associated with drifting fish aggregating devices (dFADs) in the Indian Ocean, assessed
641 through acoustic telemetry. *Fisheries Oceanography*. <https://doi.org/10.1111/fog.12536>
- 642 Govinden, R., Dagorn, L., Soria, M., & Filmalter, J. (2010). Behaviour of Tuna associated with
643 Drifting Fish Aggregating Devices (FADs) in the Mozambique Channel, 1–22.
- 644 Govinden, R., Jauhary, R., Filmalter, J. D., Forget, F., Soria, M., Adam, M. S., & Dagorn, L. (2013).
645 Movement behaviour of skipjack (*Katsuwonus pelamis*) and yellowfin (*Thunnus albacares*)
646 tuna at anchored fish aggregating devices (FADs) in the Maldives, investigated by acoustic
647 telemetry. *Aquatic Living Resources*, 26(1), 69–77. <https://doi.org/10.1051/alr/2012022>
- 648 Hall, R. L. (1977). Amoeboid Movement as a Correlated Walk. *Journal of Mathematical Biology*, 4,
649 327–335. <https://doi.org/10.1177/1077546311406307>
- 650 Hall, M. A. (1992). The association of tunas with floating objects and dolphins in the Eastern
651 Pacific ocean: VII. Some hypotheses on the mechanisms governing the association of tunas
652 with floating objects and dolphins. *Background Document for the International Workshop on*
653 *the Ecology and Fisheries for Tunas Associated with Floating Objects, February 11-13 1992,*
654 *La Jolla, CA, January, 6.*
- 655 Holland, K. N., Brill, R. W., & Chang, R. K. C. (1990). Horizontal and vertical movements of
656 yellowfin and bigeye tuna associated with fish aggregating devices. *Fishery Bulletin*, 88(3),
657 493–507.
- 658 Hughey, L. F., Hein, A. M., Strandburg-Peshkin, A., & Jensen, F. H. (2018). Challenges and
659 solutions for studying collective animal behaviour in the wild. *Philosophical Transactions of*
660 *the Royal Society B: Biological Sciences*, 373(1746), 1–13.
661 <https://doi.org/10.1098/rstb.2017.0005>
- 662 Josse, E., Dagorn, L., & Bertrand, A. (2000). Typology and behaviour of tuna aggregations around
663 fish aggregating devices from acoustic surveys in French Polynesia. *Aquatic Living Resources*,
664 13(4), 183–192. [https://doi.org/10.1016/S0990-7440\(00\)00051-6](https://doi.org/10.1016/S0990-7440(00)00051-6)
- 665 Kareiva, P. M., & Shigesada, N. (1983). Analyzing Insect Movement as a Correlated Random Walk.
666 *Oecologia*, 56(2), 234–238.
- 667 Lee, K. M., Ballard, M. S., McNeese, A. R., & Wilson, P. S. (2017). Sound speed and attenuation
668 measurements within a seagrass meadow from the water column into the seabed. *The Journal*
669 *of the Acoustical Society of America*, 141(4), 402–406. <https://doi.org/10.1121/1.4979302>
- 670 Marsac, F., & Cayré, P. (1998). Telemetry ' applied to behaviour analysis of yellowfin tuna
671 (*Thunnus albacares*, Bonnaterre, 1788) movements in a network of fish aggregating devices.
672 *Hydrobiologia*, (May 1998), 155–171. <https://doi.org/10.1023/A>
- 673 Marsac, F., Fonteneau, A., & Ménard, F. (2000). Drifting FADs used in tuna fisheries: an ecological
674 trap? *Biologie and Behaviour of Pelagic Fish Aggregations*, 537–552.
- 675 Marsh, L. M., & Jones, R. E. (1988). The form and consequences of random walk movement
676 models. *Journal of Theoretical Biology*, 133(1), 113–131. [https://doi.org/10.1016/S0022-5193\(88\)80028-6](https://doi.org/10.1016/S0022-5193(88)80028-6)
677

- 678 McClintock, B. T., King, R., Thomas, L., Matthiopoulos, J., McConnell, B. J., & Morales, J. M.
679 (2012). A general discrete-time modeling framework for animal movement using multistate
680 random walks. *Ecological Monographs*, 82(3), 335–349. <https://doi.org/10.1890/11-0326.1>
- 681 Moreno, G., Dagorn, L., Sancho, G., & Itano, D. (2007). Fish behaviour from fishers' knowledge:
682 the case study of tropical tuna around drifting fish aggregating devices (DFADs). *Canadian*
683 *Journal of Fisheries and Aquatic Sciences*, 64(11), 1517–1528. <https://doi.org/10.1139/f07-113>
- 684 Murua, H., Dagorn, L., Justel-Rubio, A., Moreno, G. and Restrepo, V. (2021). Questions and
685 Answers about FADs and Bycatch (Version 3). ISSF Technical Report 2021-11. International
686 Seafood Sustainability Foundation, Washington, D.C., USA
- 687 O’Farrill G, Schampaert KG, Rayfield B, Bodin Ö, Calmé S, Sengupta R, Gonzalez A. The potential
688 connectivity of waterhole networks and the effectiveness of a protected area under various
689 drought scenarios. PLoSOne. 2014;9(5).<https://doi.org/10.1371/journal.pone.0095049>
- 690 Ohta, I., & Kakuma, S. (2005). Periodic behavior and residence time of yellowfin and bigeye tuna
691 associated with fish aggregating devices around Okinawa Islands, as identified with automated
692 listening stations. *Marine Biology*, 146(3), 581–594. <https://doi.org/10.1007/s00227-004-1456->
693 x
- 694 Palencia, P., Rowcliffe, J. M., Vicente, J., & Acevedo, P. (2021). Assessing the camera trap
695 methodologies used to estimate density of unmarked populations. *Journal of Applied Ecology*,
696 58(8), 1583–1592. <https://doi.org/10.1111/1365-2664.13913>
- 697 Papastamatiou, Y. P., Meyer, C. G., Carvalho, F., Dale, J. J., Hutchinson, M. R., & Holland, K. N.
698 (2013). Telemetry and random-walk models reveal complex patterns of partial migration in a
699 large marine predator. In *Ecology* (Vol. 94, Issue 11).
- 700 Patterson, T. A., Basson, M., Bravington, M. V., & Gunn, J. S. (2009). Classifying movement
701 behaviour in relation to environmental conditions using hidden Markov models. *Journal of*
702 *Animal Ecology*, 78(6), 1113–1123. <https://doi.org/10.1111/j.1365-2656.2009.01583.x>
- 703 Pedro G. Lino, LLuis Bentes, David Abecasis, Miguel Neves dos Santos, & Karim Erzini. (2009).
704 *Tagging and Tracking of Marine Animals with Electronic Devices* (J. L. Nielsen, H.
705 Arrizabalaga, N. Fragoso, A. Hobday, M. Lutcavage, & J. Sibert, Eds.; Vol. 9). Springer
706 Netherlands. <https://doi.org/10.1007/978-1-4020-9640-2>
- 707 Pérez, G., Dagorn, L., Deneubourg, J., Forget, F., Filmalter, J. D., Holland, K., ... Capello, M.
708 (2020). Effects of habitat modifications on the movement behavior of animals : the case study
709 of Fish Aggregating Devices (FADs) and tropical tunas. *Movement Ecology*, 8(47), 1–10.
- 710 Robert, M., Dagorn, L., & Deneubourg, J. L. (2014). The aggregation of tuna around floating
711 objects: What could be the underlying social mechanisms? *Journal of Theoretical Biology*,
712 359(October), 161–170. <https://doi.org/10.1016/j.jtbi.2014.06.010>
- 713 Robert, M., Dagorn, L., Filmalter, J. D., Deneubourg, J. L., Itano, D., & Holland, K. (2013). Intra-
714 individual behavioral variability displayed by tuna at fish aggregating devices (FADs). *Marine*
715 *Ecology Progress Series*, 484, 239–247. <https://doi.org/10.3354/meps10303>
- 716 Rodriguez-Tress, P., Capello, M., Forget, F., Soria, M., Beeharry, S. P., Dussooa, N., & Dagorn, L.
717 (2017). Associative behavior of yellowfin *Thunnus albacares*, skipjack *Katsuwonus pelamis*,

- 718 and bigeye tuna *T. obesus* at anchored fish aggregating devices (FADs) off the coast of
 719 Mauritius. *Marine Ecology Progress Series*, 570, 213–222. <https://doi.org/10.3354/meps12101>
- 720 Romanov, E. V. (2002). By catch in the tuna purse-seine fisheries of the western Indian Ocean.
 721 *Fishery Bulletin*, 100(1), 90–105.
- 722 Scott, G. P., & Lopez, J. (2014). The use of FADs in tuna fisheries.
- 723 Siddiqui, S. I., & Dong, H. (2019). Effects of Water Column Variations on Sound Propagation and
 724 Underwater Acoustic Communications. *Sensors (Basel, Switzerland)*, 19(9).
 725 <https://doi.org/10.3390/s19092105>
- 726 South, A. (2011). rworldmap: A New R package for Mapping Global Data. *The R Journal*, 3(1), 35–
 727 43.
- 728 Swann, D. E., & Perkins, N. (2014). Camera trapping for animal monitoring and management: a
 729 review of applications. In *Camera Trapping* (pp. 3–11).
- 730 Taquet, M., Sancho, G., Dagorn, L., Gaertner, J.-C., Itano, D., Aumeeruddy, R., Wendling, B., &
 731 Peignon, C. (2007). Characterizing fish communities associated with drifting fish aggregating
 732 devices (FADs) in the Western Indian Ocean using underwater visual surveys. *Aquatic Living*
 733 *Resources*, 21(4), 331–341. <https://doi.org/Doi.10.1051/Alr:2008007>
- 734 Therneau, T. M., & Grambsch, P. M. (2000). *Modeling Survival Data: Extending the Cox Model*.
 735 *Springer*.
- 736 Tolotti, M. T., Forget, F., Capello, M., Filmalter, J. D., Hutchinson, M., Itano, D., ... Dagorn, L.
 737 (2020). Association dynamics of tuna and purse seine bycatch species with drifting fish
 738 aggregating devices (FADs) in the tropical eastern Atlantic Ocean. *Fisheries Research*,
 739 226(June 2019), 105521. <https://doi.org/10.1016/j.fishres.2020.105521>
- 740 Zvidzai M, Murwira A, Caron A, de Garine-Wichatitksy M. Waterhole usepatterns at the
 741 wildlife/livestock interface in a semi-arid savanna ofsouthern Africa. *Int J Dev Sustain*.
 742 2013;2(2):455–71